

I 、 Control panel

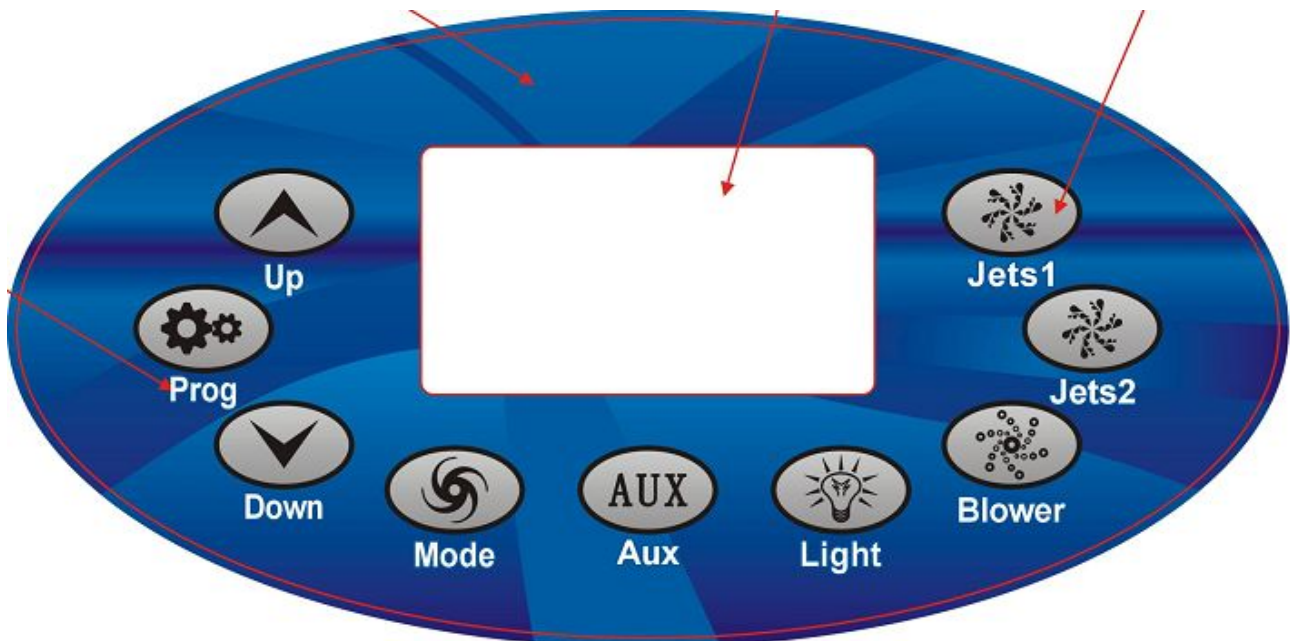

Fig1: Standard panel

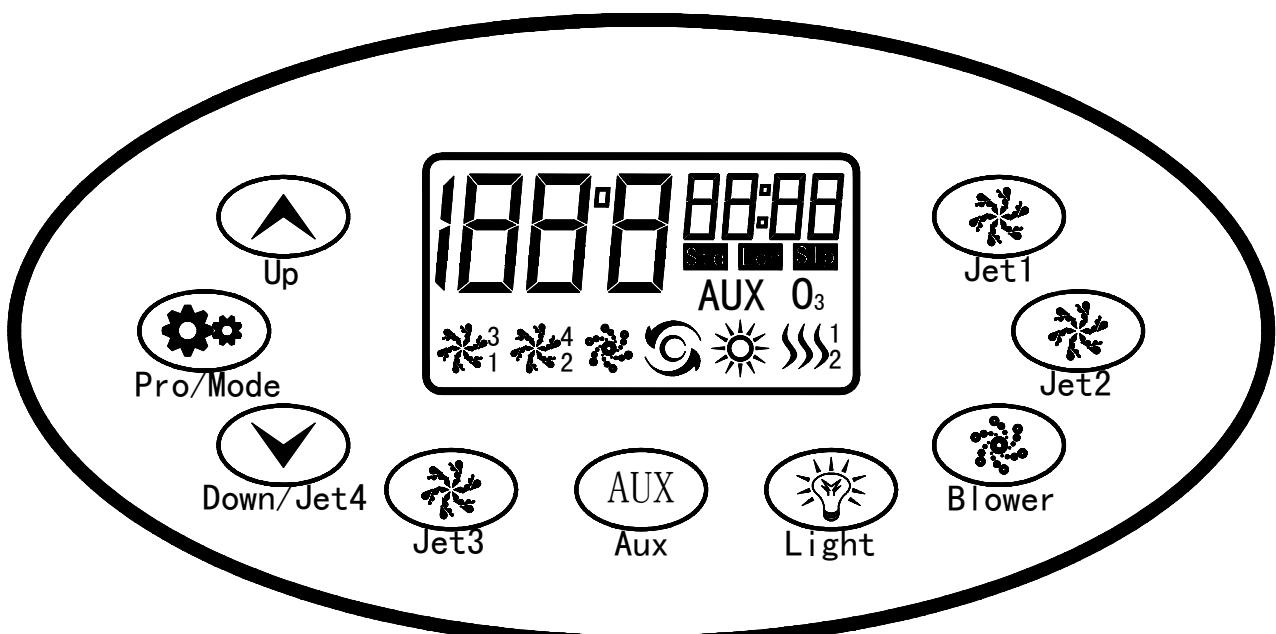

Fig2: 3/4 Surf pumps panel

II 、 Function guideline

- 1、 Three Modes: Standard mode、 Economy Mode and Sleep Mode.
- 2、 Control panels shows 24 hour system for circulation the cleaning function.
- 3、 The double control panel operation mode (sub-panel for option) .
- 4、 Max 6KW heater, display and setting of temperature under this limit too.
- 5、 Max 4 surf pumps、 1 circulation pump and 1 air blower.

- 6、Ozone function and lights color change and setting。
- 7、Fahrenheit and Celsius temperature switch function。
- 8、Water anti-freeze function。
- 9、Single or Double color keys Backlight function。
- 10、Three-phase and Single-phase, or double 110V , optional of 110-120VAC or 220-240VAC。
- 11、An extra power out for DVD or TV or other function。
- 12、Power control function is for Selection。
- 13、Error Codes/ Diagnostic message。

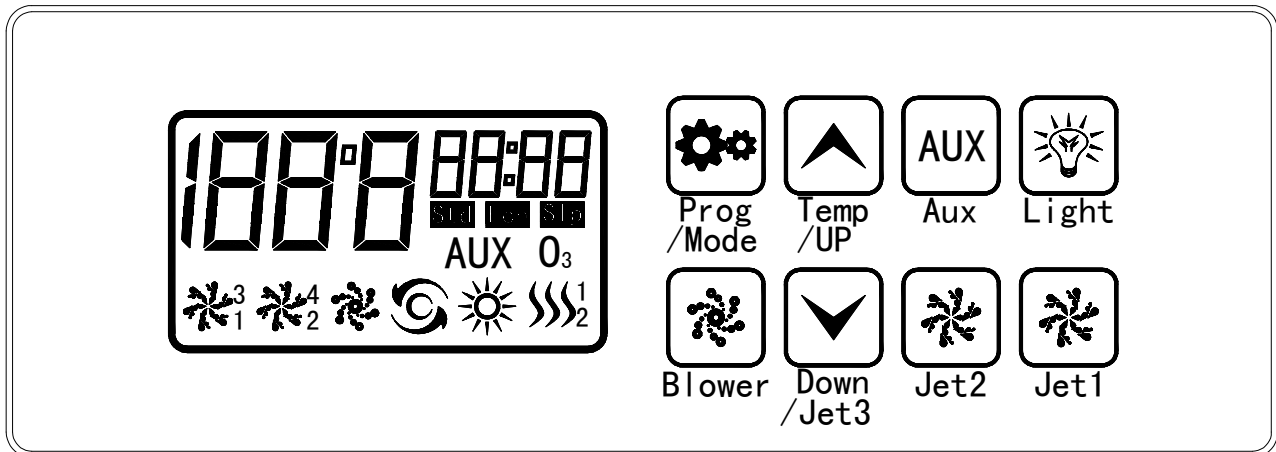

Fig3: TUCH panel



III、Function

I) Test Mode

When A8=ON, Once power on, system goes into Test Mode as: All Load will be turn on in order, And ex-factory setting or Temperature fine-adjustment setting can operate in this mode。

If A8=OFF, the system will go directly normal working mode。

II) 、Temperature Controlling (80-104°F/26-40°C)

Press “” or “” at any modes can change the temperature, press temperature button before it stopped flashing。after 6 seconds, exit temperature setting, and show the current temperature of the spa。

III) Operation of button “” :

Press “”continuely, setting mode is: “*r t c*” (Real Time Clock)→“*F S t*”

(Filter Start working time) → “*F t i*” (Filter Timer) 。

IV) MODE

1 Three Modes: Standard mode、Economy Mode and Sleep Mode。

*****Notice*****

If A1=ON, Standard Mode only.





- 2、 Press “” Change the mode:
- 3、 Standard Mode:
Standard mode keeps the setting temperature the whole day. circulation pump stop working 1 hour after the circulation is finished, doing so is to prolong the life of pump.
- 4、 Standard-in-Economy Mode:
The standard mode will change to be Economy Mode after 1 hours, and the symbol “**Std**” lights, “**Ecn**” flashing.
- 5、 Economy Mode:
Heats the spa to the setting temperature only during filter cycles.
- 6、 Sleep Mode:
Only work during filter cycles. heater will not work in this mode.
- 7、 Freeze Protection:
If the temperature sensor detect a drop to below with 45°F/7.2°C, the Freeze Protection will turn on. the pumps and blower will automatically activate 30 seconds to provide freeze protection, Heater and circulation pump keep working and control panels shows “**ICE**”。

V) 、 Filter cycles setting:

- 1、 If A2=OFF, The start working clock and continued working timer of filter cycles are fixed, The start working clock is 0: 00, The continued working timer is 3 hours.
- 2、 If A3=OFF, There are 2 filter cycles every day. The second cycle will be started 12 hours later (for example: once is 0: 00, twice is 12: 00) 。

*****Notice*****

If A2=ON, The following operation is valid.

- 3、 But only 1 circulation time can be setting. the time can be set 3、 6 and 9 hours or for continuous filtration. the default filter time is 3 hours.
- 4、 Second press of “” button, The system will go to start working clock setting, (Fig 5) 。 Press “” before the start time stopped flashing will change the start working clock-hour, minute is 00.
- 5、 After complete the start working clock setting , Press “” button again (press this button the third time) or press “” button thrice under non-setting station, the system will go to continued working timer setting. The timer can be set 3、 6、 9 hours or for continuous filtration FILC (Fig4) 。 the default filter timer is 3hours (Fig3) 。

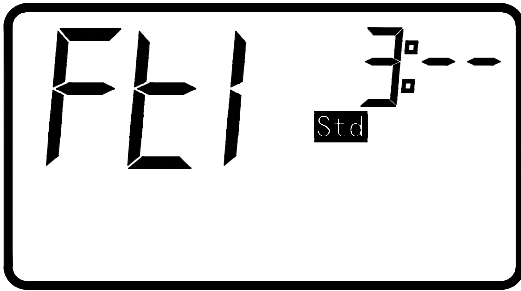

Fig4: continued working timer is 3 hours

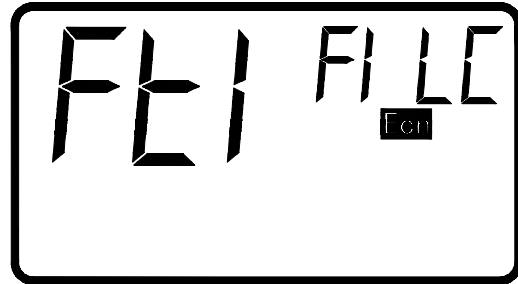

Fig5: continued working timer is Continuous

6、 At the beginning of each filter cycle all the equipment purges for 30 seconds。 during the whole cycle, the ozone generator will work at the same time, and every 15 minutes it will stop for 15 minutes to prolong the life of ozone generator。

Ozone generator will not work if any pumps or blower under working station。

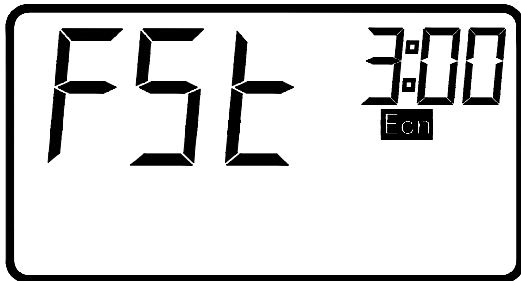





Fig6: start working clock setting



Fig7: Real time clock setting

VI) Real time clock setting:

Press “” button First to enter the Real time clock setting。 LCD shows a flashing clock (Fig6) , the clock can be changed between 0~23 hours by “” button for hours and “” for minutes (+) within “0~59”。 When the setting is finished (or no any operation) , the display will fresh automatically in 6 seconds and exit the system setting status。

VII) Main Board Wiring Configuration and DIP Settings

Notice

All DIP Setting is valid in power-up again。

- 12VAC: Ozone
- Water Level Check
- Main Board and High Voltage Board Connect
- Ethink Heater Low Voltage Line of control
- Switchbank A: System Function Setting
- Switchbank B: High Voltage Load Setting
- 12VAC: Spa Light
- 12VDC: Spa Light (Selection)

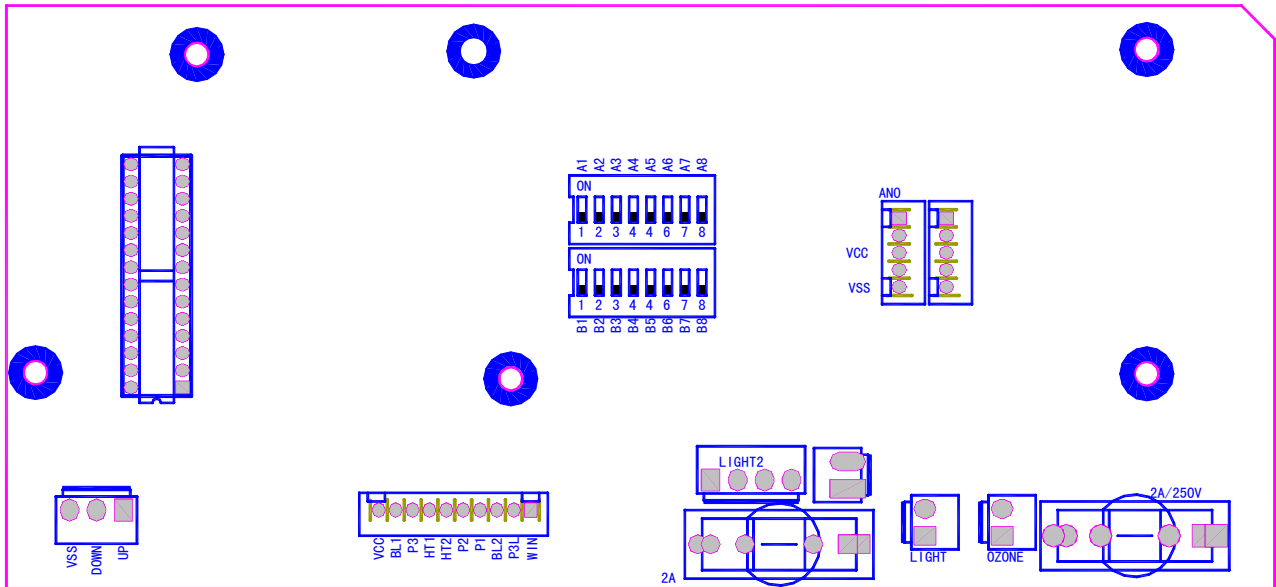

Fig8: Main board

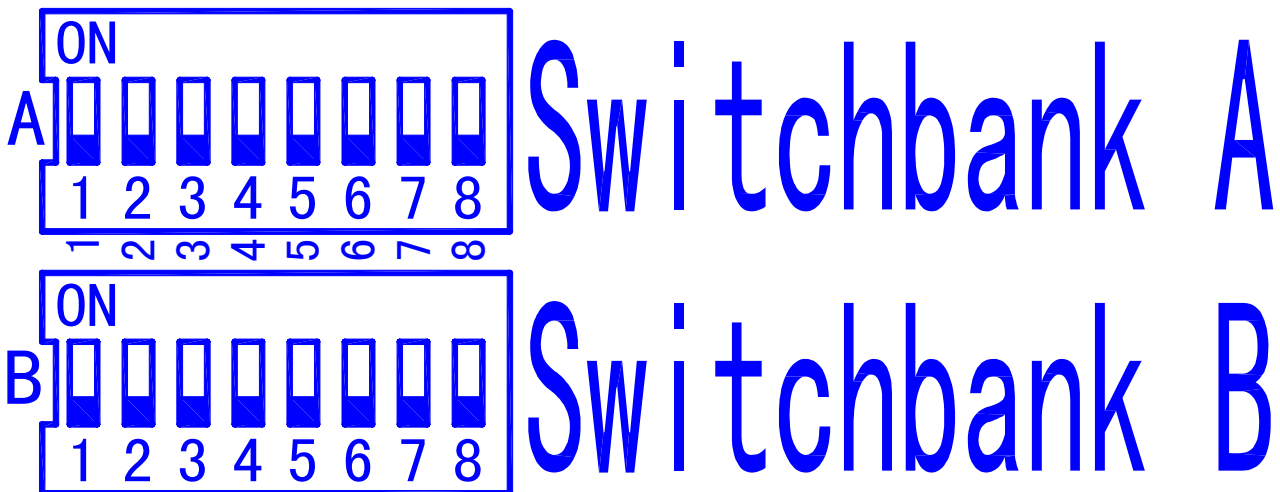





Fig9: Switchbank A/B

- A1: OFF: Std/Ecn/Sleep Mode changes allowed.
ON: Standard Mode only.
- A2: OFF: Filter cycles opening time and continuous working timer are changeless.
ON: Filter cycles opening time and continuous working timer man-made Setting
- A3: OFF: Filter cycles will work twice a day.
ON: Filter cycles will work once a day.
- A4: OFF: Displays Temperature in Fahrenheit.
ON: Displays Temperature in Celsius.
- A5: OFF: Main Control Panel only.
ON: Main Control Panel +Sub- control panel.
- A6/A7=OFF/OFF: All Load can work simultaneity.
=ON/OFF: When two Surf Pumps or blower working, The Heater be allowed working
=OFF/ON: When one Surf Pump or blower working, The Heater be allowed working
=ON/ON: When one Surf Pump or blower working, The Heater will be close

A8: OFF: normal working mode。
ON: test mode

B2/B1: Selection Surf Pumps

B2	B1	Surf Pumps	B3	Key “  ”	Key “  ”	Key “  ”	
OFF	OFF	2	×	BLOWER	×	×	Standard panel
OFF	ON	3	ON	PUMP3	×	×	
			OFF	BLOWER	PUMP3	×	3/4Surf
ON	×	4	ON	PUMP4	PUMP3	×	Pumps panel
			OFF	BLOWER	PUMP3	PUMP4	

注：“×”表示为未用。

B3: Only applies When B1=ON or B2=ON

OFF: The key of “” control blowe

ON: The key of “” control Surf Pump3/4.

B5: OFF: Single-speed Pump1

ON: Two-speed Pump1

B6: OFF: The Heater is ETHINK Heater.

ON: The heater is Hot Pump.

B7: OFF: There is not Manual water draining.

ON: There is Manual water draining.

B8: OFF: There is water flow switch (Heater)。

ON: There is not water flow switch (Heater)。

VI.High voltage board description and operation

I) Operation for Surf pumps:

The surf pump will stop automatically after working 60 minutes.

If there is no water in spa or water level lower than requested, all pumps will flash when start.

II) Operation for air blower:

The key “” is for controlling the blower。The blower will be off automatically after start 25 mins.

If no blower and this key is for controlling the surf pump3, It will stop automatically after working 60 minutes.

III) Extra function button:

“” button is the extra function button。the purpose is for customer to add more

function. it will stop automatically after it works 60 minutes.

IV) Operation for light:

Button “” for On/ OFF

V. Diagnostic message:

Message	Meaning	Solution/ action required
“SnA”	Temperature sensor is not connected or get short circuit	1、 Check If pin is loose or damaged 2、 Change main board if pin connected well. 3、 Heater must be changed if changing main board can't fix problem.
“Snb”	Water sensors is not connected or get short circuit	
“oHb”	Water sensors over the limit	
“oHH”	Heater inside temperature reach or higher 118°F/48°C	1、 Check if surroundings temperature is too high or not 2、 Check filter if blocked or newly changed 3、 Check if circulation pump is fine or not, and check flow valve is in right way or not.
“oHS”	Heater inside temperature reach or higher 110°F/43.5°C	
“HFL”	Water flow is too low in heater	1、 Check filter if blocked or newly changed 2、 Check if circulation pump is fine or not, and check flow valve is in right way or not. 3、 If both above is normal, cut power and turn it on 15 seconds later then reset system.
“LF”	Confirm the water flow is insufficient in heater	
“dry”	No water or water level fail to reach	1、 Check if water level meet requested. 2、 Check all pins about water level sensors to see if in normal station.

Other message:

- 1、 “ICE” : Inspected freezing, and will start freeze protection function.
- 2、 “InF” : automatic water replenishing is operating, other functions are in normal station.



KL8500B Spa operation manual

VI、 Electric Parameter

1、 Capability guideline:

Operation voltage: AC220-240V/50Hz Limited Current: 60 A/220V
(or 110-120V/60Hz) (100A/110V)

Ability to endure Pressure: 1250V/1 min, no Puncture

Insulated Resistance » 200MΩ

Waterproof grade: IPX5

Guards against receives an electric shock: 1 kind

2、 The biggest output guideline:

Heater: AC220V/3KW×2 Surf pump: AC220V/3HP×4
(AC110V/1.5KW×2) Circulation pump: AC220V/1HP

Air blower: AC220V/800W Light: AC12V/20W

ozone: AC12V/8W DC12V/20W